

YAKOS's responsibility is to provide customers with comprehensive solutions. Please let us know what you are looking for so that we can process your inquiry as quickly and efficiently as possible.

For more detailed information, please visit YAKOS website at www.yakos65.com



SAFZONE

ECO[®]



yakos  **TRIED & TRUSTED**

Biological Safety Cabinet | Flammable Safety Storage Cabinet | Zebrafish Housing System | Chemical Fume Hood | Radiopharmacy Safety Cabinet

Chung Fu Technical Development Co., Ltd.

No.33-1, Nanshih, Linkou Dist., New Taipei City 244, Taiwan

TEL: +886 2-2600 1761

FAX: +886 2-2600 6901

WEBSITE: www.yakos65.com

EMAIL: sales@yakos65.com

Biological Safety Cabinets

The First-rate Protection for Operators, Products and Environment





YAKOS 40 Years of Manufacturing Experience

SAFZONE® Biosafety Cabinet is a safety device to protect the operator, product and environment. It is designed to work with agents that require Biosafety Level 1 ~ 3 containment, such as biohazardous agents, nature microbial strains and clinical diagnostic inspection samples. It is made to meet the specific requirements of NSF49 and EN12469. SAFZONE® Biosafety Cabinet can help to avoid exposure to possible infectious aerosols and spills during the operation.

SAFZONE® Class II type A2 Biosafety Cabinets maintain negative pressure environments inside the cabinet to prevent the contaminants from escaping the work area to protect the operator. Approximately 70% of the room air is pressurized by the blower and forced through the supply HEPA filter prior to entering the work area, to protect the product. Finally, the remaining 30% of air is filtered through an exhaust HEPA filter. The sterile air finally exits the cabinet and is released back into the room to protect the environment.

As a trusted brand, YAKOS's products and services continue to be strictly regulated and our high quality manufacturing facilities have been specifically used for the development of BSC products. SAFZONE® Biosafety Cabinets undergo thorough quality testing before being released, to ensure consistent quality for your piece of mind.

Application for cell culture, pharmaceutical, clinical and microbiological work at: Hospitals, Universities, Research Centers, Pharmaceutical Companies, Food Industries and other Biological / Life Science Laboratories.



Hospital



University



Research Center







Pharmaceutical



Biological labs

YAKOS is devoted to maintaining the highest standards and professional certifications attainable in the industry. SAFZONE® Biological Safety Cabinets have been designed, manufactured and tested to comply with the following standards and regulations to provide the highest level of protection for operator, product and environment when working at biosafety level 1, 2 and 3.

Biological Safety		NSF 49 (Class II type A2): Biosafety Cabinetry - Design, Construction, Performance and Field Certification.
		EN 12469 (Class II): Biotechnology – Performance criteria for microbiological safety cabinets.
Electrical, Mechanical, Fire and Personal Safety		IEC 61010-1: Safety requirements for electrical equipment for measurement, control, and laboratory use.
Air Cleanliness		ISO14644-1 (Class 4): Classification of air cleanliness by particle concentration.
HEPA Filters		EN1822: Classification of HEPA filters by retention at the given most penetrating particle size (MPPS).
Quality Management System		ISO 9001: Quality management system requirements for facilities, people, training, services and equipments.

Multiple Protection Design

HEPA Filter

The Class H14 (per EN1822), 99.99% efficiency at 0.3 microns for Supply and Exhaust HEPA filters are used on SAFZONE® Biosafety Cabinets to provide ISO Class 4 clean air to the work area and remove 0.3 micron particulates before exhausting to the environment.

Lighting

An average light intensity of more than 1,000 lux at the work surface. The lighting positioned outside the working area without disturbing the downflow and creating obstructions for cleaning. The LED light will be activated automatically when the sash is open and turns off when the sash is fully closed.

Germicidal Ultraviolet Light

The UV light on SAFZONE® BSC is a standard feature that is designed to provide a minimum average intensity of 40 microwatts per cm² at the cabinet work surface. A safety interlock prevents operation of the UV light unless the window view screen is fully closed.

Work Area

SUS#304 Single-piece stainless steel liner and work tray. Radius corners make easier to clean the work area. Removable single-piece work tray can be easily removed for cleaning and collection of spilled liquid.

Adjustable Support Stand

Fully assembled support stand with telescoping leg and leg levelers. The stand can be adjusted from 560-860 mm to meet the working height for each operator. Stand with brake casters is available for option.

※Please adjust the stand height first before installing the cabinet on the stand.



Key switch power

A security control to prevent operation by unauthorized person.

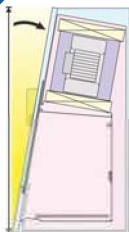

Ergonomic Design

Ergonomic 10 degrees angle window design. Coupling with adjustable stand allows more comfortable viewing and less fatigue of arms, shoulders and neck over long time use.

Easy Operation, Easy Maintenance, Easy Security

An external, adjustable, airtight Damper

Allows the certifier to regulate the balance of inflow and downflow.

ECM DC Motor

ECM DC motor provides energy-saving, accurate constant air flow, high efficiency and low maintenance characteristics. Automatically compensates for an increase in pressure drop due to filter loading without reducing the total air flow rate.

Advanced 5 inch Human Machine Interface Touch Screen

With a good graphic view for easy operation and function settings and continuous displays the cabinet's performance status.

Membrane Switches and Pressure Gauge Control Panel

Built-in UV light timer for 0-99 minutes / hours and negative plenum pressure gauge. Safety interlock device controls blower, fluorescent light and UV light on/off.

6mm Tempered Safety Glass Window Sash

UV resistant tempered safety glass. With high accuracy monitoring sensors, an audible and visual alarm activated when the sash is not at the specified operation height.

Surround Air Intake Grille

Unique surround air intake grille design contains all contaminated air inside the cabinet and drawn back to blower through the surround intake grilles including window side without safety dead end.



Paper Catch

The paper catch is located at the bottom of the rear return-air plenum. Acting as a protective screen preventing wipes and other materials from being drawn into the blower system.

Electrical Outlets / Sockets

Two kinds of optional electrical outlets mounted on the rear wall of SAFZONE® BSC to power instruments inside the work area. The outlets are rated at 5 amps and the circuit powering the outlets are protected by a self-resetting circuit breaker, which allows a total of 5 amps on all outlets. This helps protect the primary cabinet controls from inadvertent overloads of the cabinet outlets.



115V/60Hz
 North America (UL listed)



220V/50,60Hz
 Europe/Worldwide (CE Certified)



Maximum Protection for Operator, Product and Environment

Double-wall structure surrounded with negative pressure to fully prevent leakage of contaminated air in the event of damage to the cabinet external walls.

SAFZONE® Biosafety Cabinets create inflow to protect the operator, HEPA-filtered laminar downflow for product protection and exhaust air from cabinet through HEPA filter for environmental protection. SAFZONE® Biosafety Cabinets can prevent the aerosols generated during operation from harming the external environment or the operator itself and can also reduce cross-contamination between products due to aerosols.

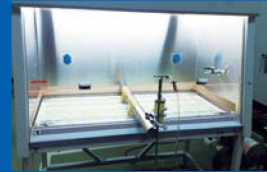
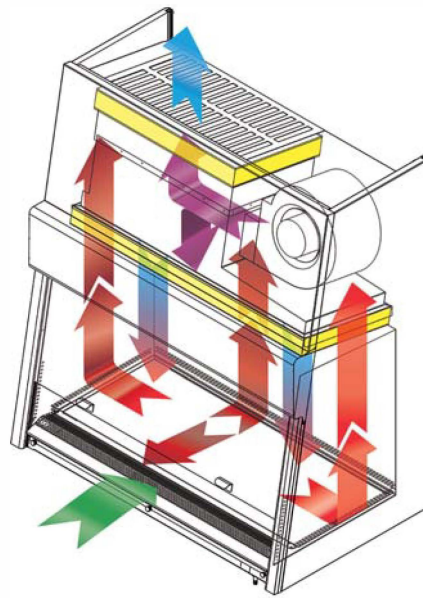

Out of balance tests performed at ±10 fpm nominal set points for both inflow and downflow, SAFZONE® Biosafety Cabinets still maintain an excellent enclosure for operator & product protection biological challenge tests as well as smoke patterns tests.



Surround air intake grille design – All contaminated air is isolated inside the cabinet to maximize the Biosafety Cabinet protective capabilities. It prevents aerosols, vapors and particulates escaping into the operator's environment from the front opening or window sash edges of cabinet.

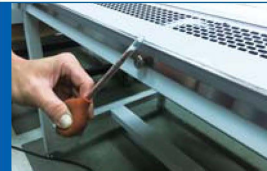

Inward airflow of 0.51 m/s velocity to the open front for operator protection.

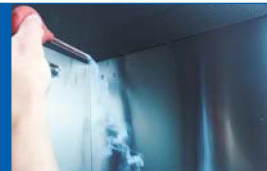

The Supply HEPA filter provides ISO Class 4 (per ISO14644.1) clean air to the work area in a gentle vertical laminar flow, for product protection.

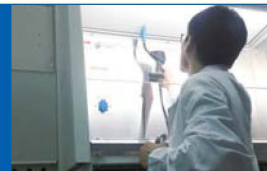

QUALITY & PERFORMANCE GUARANTEE

A Factory Testing Report will be enclosed with each SAFZONE® Biosafety Cabinet. The following performance and safety tests being conducted before leaving the factory.

- Pressure decay test
- HEPA filter leak test
- Inflow velocity test
- Downflow velocity test
- Airflow smoke patterns test
- Lighting intensity test
- Vibration test
- Noise level test
- UV lighting intensity test
- Electrical safety test



GREEN POWER TECHNOLOGY

SAFZONE® Biosafety Cabinets apply the world's highest level ECM DC motors to provide energy savings and accurate constant air flow with high efficiency and low maintenance characteristics. The motor control automatically compensates for an increase in pressure drop across the filters due to filter loading without reducing the total air flow rate and ensuring the airflow at set point. This results in extending HEPA filter life and reducing the filter replacement and decontamination costs.



- Easy Installation & Service
- Moisture Resistant Design
- Ultra High Efficiency

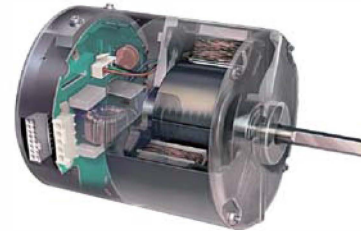

ECM Brushless DC Motor

Key Benefits:

- Energy-saving: Constant air flow design adjusts air pressure automatically providing programmed air flow and extend HEPA filter life.
- Automatically compensates for an increase in pressure drop across the filters due to filter loading.
- High torque and superior efficiency.
- No manual motor speed control required.
- Less heat generated - The temperature raised inside the cabinet for 8 hrs ECM motor operation is less than 1°C.
- Stable motor output can withstand 6KV external surge circuit.



Night-idle Mode

30% motor speed output only

Whether you are on break, temporarily away from the cabinet or at home, the cabinet may be used in Night-idle Mode. Upon sliding the sash to closing position, the smart speed control automatically reduces the motor speed to 30% at Night-idle Mode. This ensures the cabinet at a sterile working situation and saves significant electricity costs and extends HEPA filter life. When the sash is opened, the motor automatically resumes normal operation mode.

CONTROL SYSTEM SELECTION

Modular electronic components and neat wiring layout applied on SAFZONE® Biosafety Cabinets to simplify the maintenance work. Electronic parts are easily accessible and easy to reach for the operator from the drop down control panel. Control systems and pipelines completely isolated from contaminated areas for convenient and safe maintenance.

7 Inch HMI Touch Screen



Advanced Human Machine Interface (HMI) Touch Screen mounted on SAFZONE® BSCs to provide user with a better graphic view for easy operation and function settings and continuously displays the cabinet's performance.

- High resolution LCD display visualizes operating, monitoring and efficient control in real time.
- The large 5 inch full color touch screen enables intuitive parameter entry and displays variable data, including trend graphs and alarm elements.
- User-friendly visual icons quickly creates users an "easy-to-navigate" to make operation more efficient.
- Display real time clock and date, inflow, downflow, negative plenum pressure, HEPA filter running hrs, UV lamp running hrs at the front page.
- Main functions include:
 - Automatic Pre-purge / Post-purge
 - Built-in timer for counting up and down, UV light
 - Safety interlock for window and UV light to protect the operator from UV irradiation
 - Audible and visual text alarms for the following abnormal situations:
 - High / Low inflow velocity
 - High / Low downflow velocity
 - Wrong window operation height
 - High negative plenum pressure
 - Usage time of HEPA filter exceeds the setting hour
 - Usage time of UV lamp exceeds the setting hour
 - Multi-language display setting
 - Two kind of unit display settings for air velocity and pressure



Easy access and maintenance for the service personnel

Membrane Switch Control Panel with Pressure Gauge



Membrane Switches are easy to use. Built-in UV light timer for 0-99 minutes / hours and negative plenum pressure gauge. Safety interlock device controls blower, fluorescent light and UV light on/off by window sash open and closed.

WINDOW ALARM	When the window is not at the operation height, it will release an audible and visual alarm automatically.
MUTE SWITCH	When the alarm is activated, it can be muted temporarily while the alarm light continues to flash. If the abnormal situation has not been settled, the cabinet alarm will be activated again within a set time (5 minutes) to alert the operator.
SAFETY INTERLOCK	When the window is opened, the blower and fluorescent light will be activated automatically and the UV light will be switched off. When the window is fully closed, the UV light will be re-activated automatically. The blower and fluorescent light will be switched off.
UV LIGHT TIMER	Built-in UV light timer for 0-99 minutes / hrs.
PRESSURE GAUGE	Displays the negative plenum pressure of the cabinet in the unit of mm Aq.

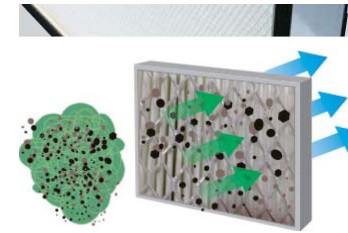
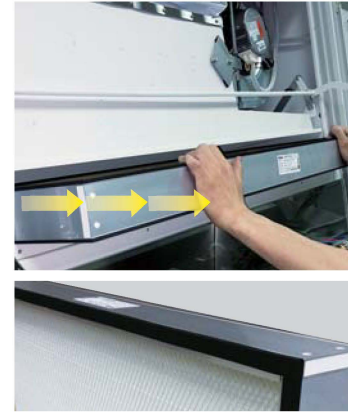

Patented Quick-Access HEPA Filter Replacement System

Filter replacement is no longer a hard work!!

Only one man and one minute to complete the filter changing without any tools!!

SAFZONE® patented innovative HEPA filter replacement system enables the filter changing safely, time-saving and manpower-saving. Without any tools, the filters can be replaced from the front side of the cabinet more easily and quickly than other brands.

The Class H14 (per EN1822) Supply and Exhaust HEPA filters are used on SAFZONE® BSCs. The HEPA filters consist of a continuous sheet of glass fibers pleated and mounted in a rigid aluminum frame (Aluminum extruded frame can increase strength and rigidity for corrosion resistance). With minimum 99.99% efficiency for 0.3 micrometers particulates (MPPS, the Most Penetrating Particle Size) creates a clean, sterile environment for operation zone and workplace. The efficiency will be more than 99.99% for particulates greater or smaller than 0.3 micrometers.

Key Features for HEPA filters on SAFZONE BSCs

1. Allow more 20-50% of air to flow through the HEPA filters than ULPA filters to maintain optimum cleanliness of operation zone.
2. Lower pressure drop/loss and longer filter life than ULPA. High pressure drop will cause more energy consumption and cost.
3. The removal efficiency increases for greater or smaller than 0.3 micrometers particulates.
4. Both the supply and exhaust HEPA filters are scan-tested and efficiency-tested after installation in the cabinet.
5. Provide cleanliness Class 10 air to the work area in a gentle vertical laminar flow for product protection and remove 0.3 micron particulates for environmental protection.

※ HEPA filters are not intended to filter chemicals, gasses or vapors. Since this cabinet is partially recirculating, there could be gaseous buildup if gases or vapors are used. Misuse of chemicals, Bunsen burners, or a heavy dust load will shorten the filter's life.



- Double-wall cabinet structures. Contaminated area surrounded with negative pressure to fully prevent leakage of contaminated air.



Innovative surrounded air intake grill design. All contaminated air in the work area is enclosed inside the cabinet. No safety dead end; the safety of personnel is never compromised.

- The ECM brushless DC motor Best Energy efficiency.
- Supply/Exhaust HEPA filter 99.99% efficiency @0.3 micron (Class H14)

- Ergonomic 10 degree angle window design, reduces discomfort over long-term use of limbs and eye-strain.

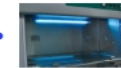

6mm anti-ultraviolet tempered glass.

- 10 performance & safety tests before leaving the factory under strict quality control process.

Specification				
Model	3 feet	4 feet	5 feet	6 feet
International Certification	• EN 12469 • ISO 9001:2015	• NSF 49 (25cm) • EN 12469 • ISO 9001:2015	• EN 12469 • ISO 9001:2015	• EN 12469 • ISO 9001:2015
External Dimensions W×D×H (without support stand 660 mm)	1034×789×1537 mm	1334×789×1537 mm	1634×789×1537 mm	1934×789×1537 mm
Internal Dimensions W×D×H	920×626×709 mm	1220×626×709 mm	1520×626×709 mm	1820×626×709 mm
Cabinet Main Construction	<ul style="list-style-type: none"> Working area: Stainless Steel#304 (Option: Viro-cut stainless steel, SUS#316) External construction: Cold-rolled steel with powder coating finish 			
Air Flow	70% re-circulated / 30% exhausted			
Window Operation Height	20 cm, 25 cm			
Avg. Inflow Velocity	0.51 m/s			
Avg. Downflow Velocity	0.325 m/s	0.30 m/s	0.30 m/s	0.30 m/s
Exhaust Air Volume with Exhaust Canopy	9m ³ /min (20cm) 10m ³ /min (25cm)	11m ³ /min (20cm) 13m ³ /min (25cm)	14m ³ /min (20cm) 16m ³ /min (25cm)	17m ³ /min (20cm) 19m ³ /min (25cm)
Supply/Exhaust HEPA Filter	99.99% @0.3 micron (Class H14)			
Light Intensity	> 1,000 lux			
Sound Level	< 55dBA (20cm) < 58dBA (25cm)	< 57dBA (20cm) < 63dBA (25cm)	< 59dBA (20cm) < 60dBA (25cm)	< 61dBA (20cm) < 62dBA (25cm)
UV Lamp	254 nm/ FL 20W×1	254 nm/ FL 30W×1	254 nm/ FL 40W×1	254 nm/ FL 20W×2
LED Lamp	T5/21W×2	T5/28W×2	T5/35W×2	T5/21W×4
Window Glass	6mm tempered glass			
Electrical Outlets	North America (UL Listed), Europe/Worldwide (CE Certified)			
Optional Accessories	<ul style="list-style-type: none"> IV bar with 6 hooks / hanging basket Service valves(air, gas, vacuum) , CSA Certified Exhaust canopy Brake casters Moveable elbow / arm rest 			
Room Height Suggested	227cm at least			
Power	115V / 15A			
Consumption	185W (20cm) 220W (25cm)	230W (20cm) 300W (25cm)	380W (20cm) 400W (25cm)	430W (20cm) 490W (25cm)
Net Weight	210 kg	240 kg	280 kg	320 kg
Shipping Weight	240 kg	280 kg	320 kg	370 kg
Shipping Dimensions W×D×H	1100×850×1950±30mm	1400×850×1950±30mm	1700×850×1950±30mm	2000×850×1950±30mm

Ordering Guide – Model Number					
Cabinet Model	3 feet	4 feet	5 feet	6 feet	Window Position
Touch Screen / 115V,60Hz	AHA-103-AA-A	AHA-133-AA-A	AHA-163-AA-A	AHA-193-AA-A	20 cm
	AHA-103-AA-B	AHA-133-AA-B	AHA-163-AA-B	AHA-193-AA-B	25 cm
Touch Screen / 220V,50/60Hz	AHA-103-AB-A	AHA-133-AB-A	AHA-163-AB-A	AHA-193-AB-A	20 cm
	AHA-103-AB-B	AHA-133-AB-B	AHA-163-AB-B	AHA-193-AB-B	25 cm
Touch Screen / 100V, 50/60Hz	AHA-103-AC-A	AHA-133-AC-A	AHA-163-AC-A	AHA-193-AC-A	20 cm
	AHA-103-AC-B	AHA-133-AC-B	AHA-163-AC-B	AHA-193-AC-B	25 cm
Membrane Switch / 115V,60Hz	AHA-103-CA-A	AHA-133-CA-A	AHA-163-CA-A	AHA-193-CA-A	20 cm
	AHA-103-CA-B	AHA-133-CA-B	AHA-163-CA-B	AHA-193-CA-B	25 cm
Membrane Switch / 230V,50/60Hz	AHA-103-CB-A	AHA-133-CB-A	AHA-163-CB-A	AHA-193-CB-A	20 cm
	AHA-103-CB-B	AHA-133-CB-B	AHA-163-CB-B	AHA-193-CB-B	25 cm
Membrane Switch / 100V, 50/60Hz	AHA-103-CC-A	AHA-133-CC-A	AHA-163-CC-A	AHA-193-CC-A	20 cm
	AHA-103-CC-B	AHA-133-CC-B	AHA-163-CC-B	AHA-193-CC-B	25 cm

Cabinet Dimension Drawings

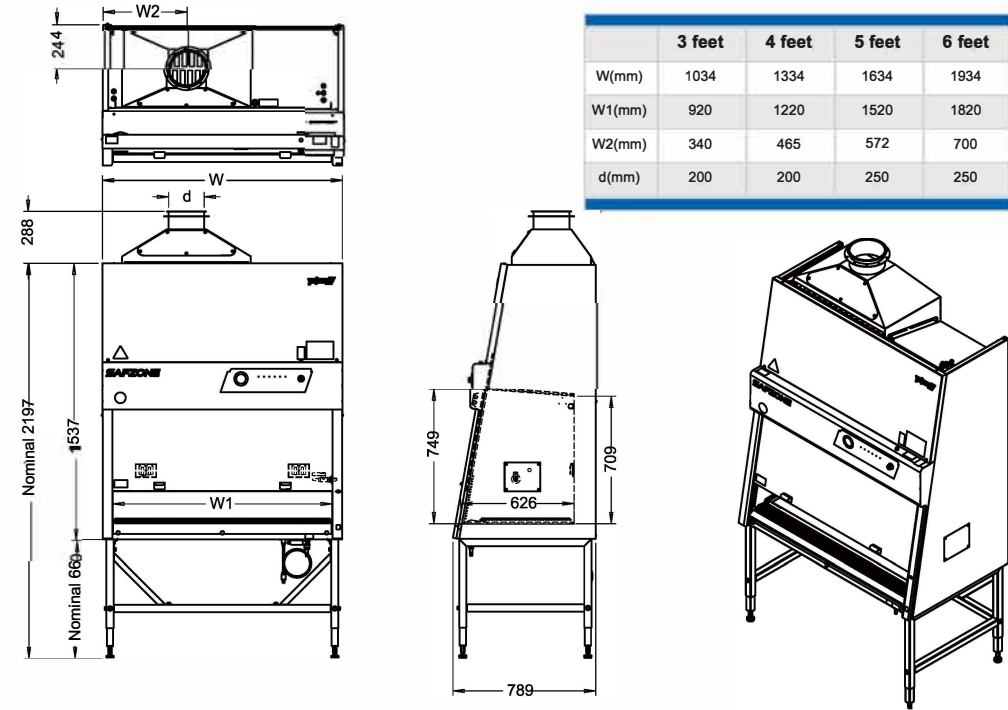

	3 feet	4 feet	5 feet	6 feet
W(mm)	1034	1334	1634	1934
W1(mm)	920	1220	1520	1820
W2(mm)	340	465	572	700
d(mm)	200	200	250	250

Quality Components & Accessories



IV Bar & Hanging Basket

The cabinet can be equipped with a SUS#304 Intravenous (IV) Bar and Basket to facilitate the hanging of required materials.

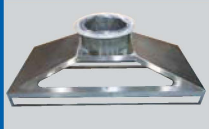

Exhaust Canopy

SUS#304 Canopy provides air gaps on 4 sides to allow air to enter the ductwork and mix with the filtered exhaust air released into the atmosphere. It expands the use of SAFZONE[®] Class II type A2 BSCs to work with small amounts of volatile chemicals and radionuclides adjunct to microbiological studies.



Moveable Elbow / Arm Rest

The SUS#304 Moveable Elbow / Arm Rests (set of two) provide ergonomic forearm support, comfortable working posture and prevent grille blocking.



Brake Casters

Available with a set (4) of 4" diameter, toe-locking polypropylene casters with bearings. Loading capacity for each caster is 140 kg. The casters can be directly installed on the telescoping support stand.